

You
Are The
Guaranteed
Winner of
**ONE
MILLION
ZORKMIDS***

**if you hold the
winning number*

SPELLBREAKER

Just when things seem at their worst, you might find yourself the lucky winner of a fabulous prize in our all-new "Map Your Future" Sweepstakes!

GRAND PRIZE: One Million Zorkmids

to spend however you like!

2 FIRST PRIZES:

Live like a king in the castle of your dreams! We'll build to your specifications - anything you want up to 100,000 zorkmids!

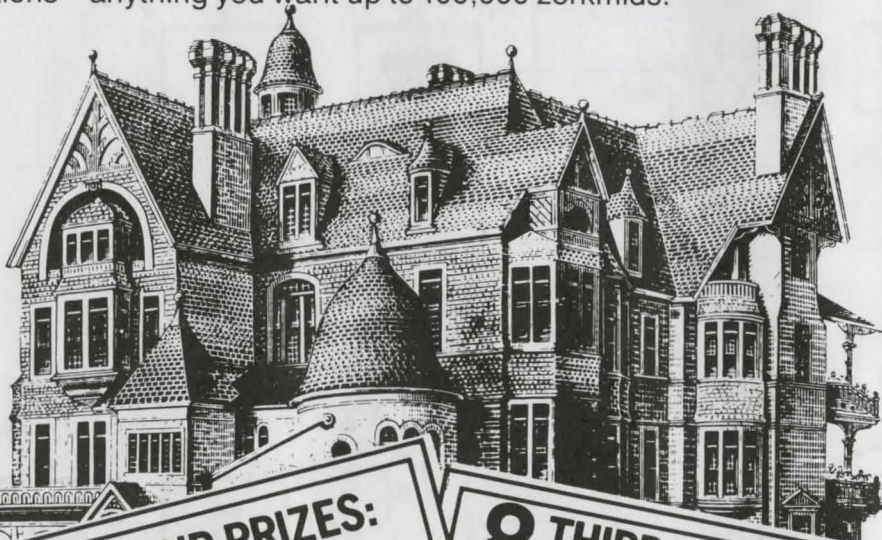

5 SECOND PRIZES:

Put yourself in the driver's seat of a magic carpet specially designed by Zooble Belbort! Complete with tail fins, tachometer, and wet bar.



8 THIRD PRIZES:



Tune in to the universe with your own ninety-six channel, high-frequency auroscope.

Hear important notes and variations days before your fellow enchanters!

100 FOURTH PRIZES:

(shown actual size)



Dazzle your friends with a genuine 10 point sapphire, set in a unique band of twisted gold.

Map Your Future

Sweepstakes Instructions

Using the enclosed map, fill in the blanks in the following statements. Only entry forms with completed statements will be eligible. Mail your entry form to: "Map Your Future" Sweepstakes, Frobozz Magic Magic Equipment Company, Borphee.

1. You'll need to use your Frobozz Magic Magic Equipment Company luminstone to avoid being eaten in the _____ Cave.
2. You might want to **sow** some Frobozz Magic Magic Equipment Company magnetic bozberry seeds in the _____.
3. The carpets sold at the _____ cannot match the strength and reliability of those offered by the Frobozz Magic Magic Equipment Company.
4. The _____ is the perfect place to show off your Frobozz Magic Magic Equipment Company flame-resistant alchemist's jumpsuit.
5. There is _____ like home, unless it is the Frobozz Magic Magic Equipment Company outlet store in Borphee, open 7 days a week, dawn to dusk.

Please Send Me:

- LUMINSTONE.** Frotz spell on the blink? Our luminstone emits a purple glow to light your way. Keep it in your pocket for those unexpectedly Dark moments. Zm15.
- BOZBERRY SEEDS.** Having trouble maintaining a protective circle? Magnetic bozberry leaves draw evil forces out of your home and into the bozberry root, where they are rendered harmless. Brightly-colored plants are easy to grow. Zm9 per pack of 25 seeds.
- MAGIC CARPET.** Treat yourself to a new Contortayarn carpet. Reduced in price from our Special Crisis Edition Catalog! Blue beetle design only. Zm430.
- ALCHEMIST'S JUMPSUIT.** No need to worry about trying unusual metal combinations when you're wearing our flame-resistant jumpsuit. Fully fashioned of 100% fugron. One size fits all. Zm26.

I enclose Zm _____.

Name _____

Address _____



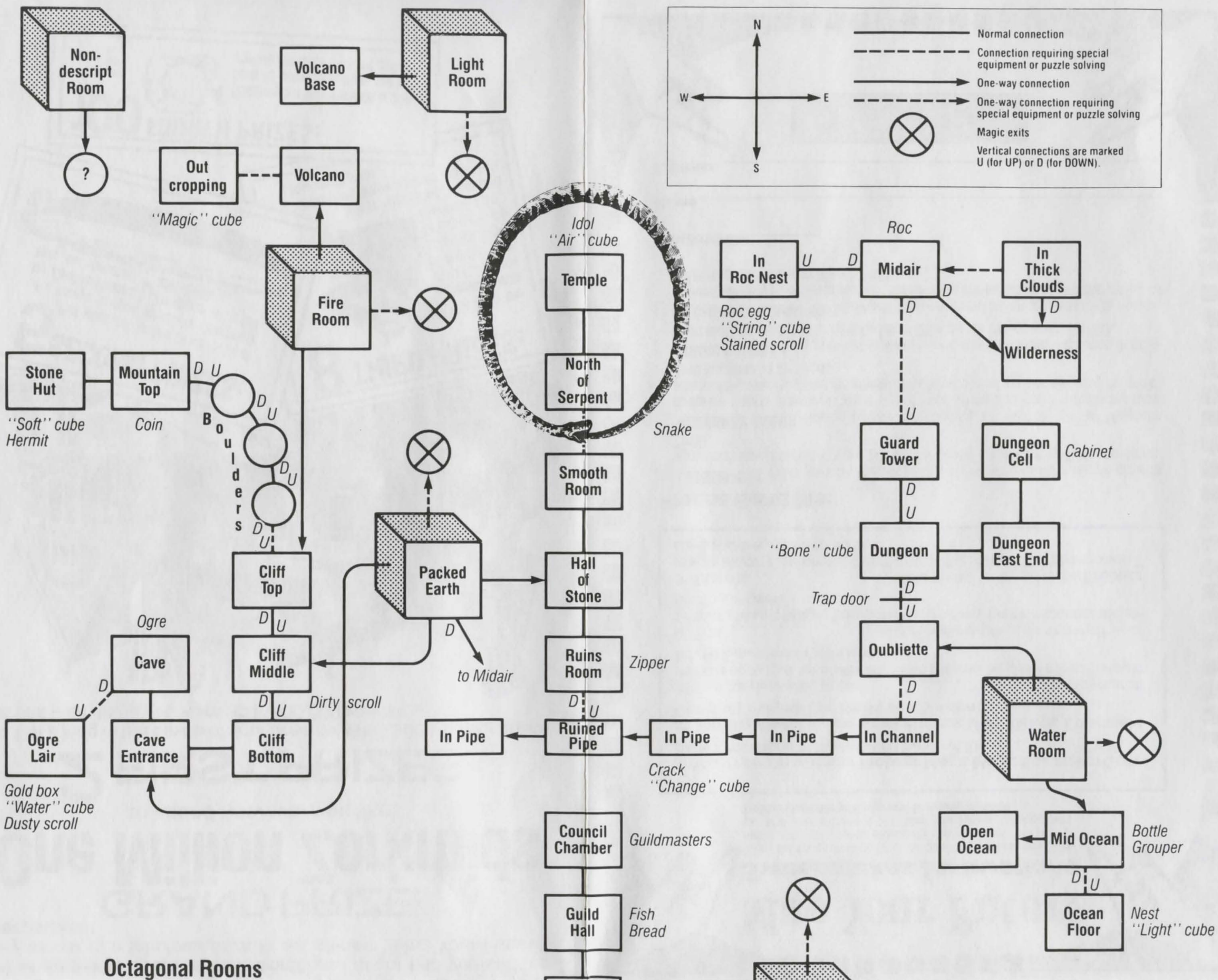
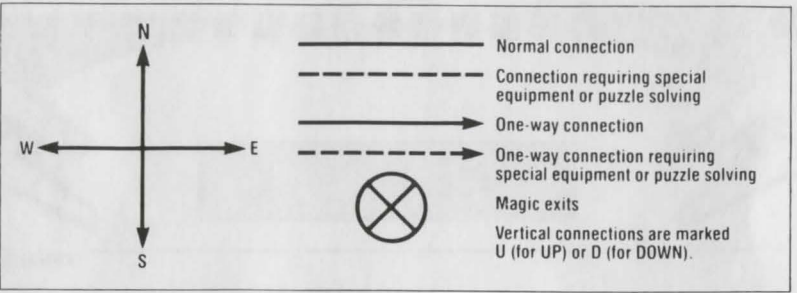

Octagonal Rooms

'No place'
cube

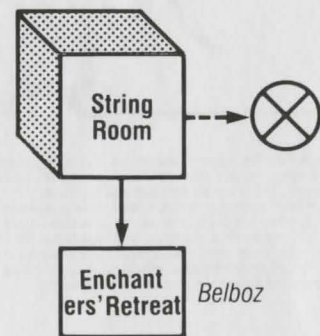
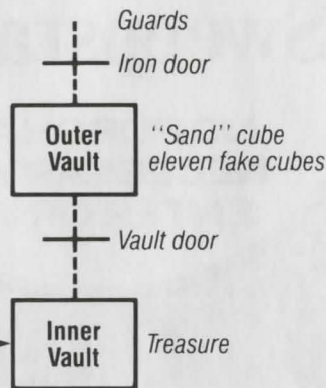
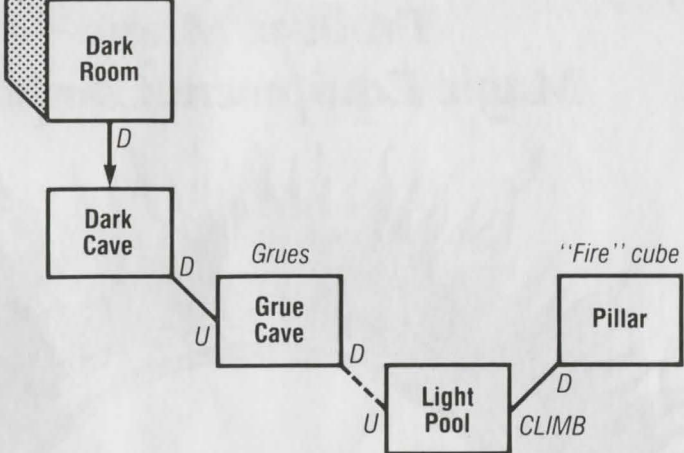
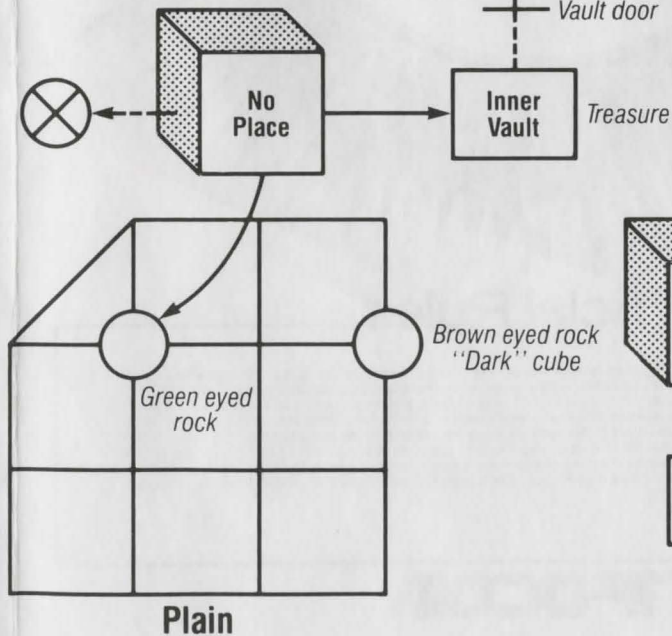
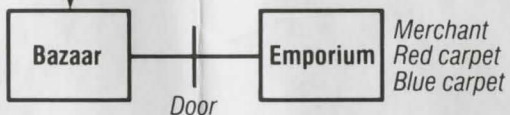
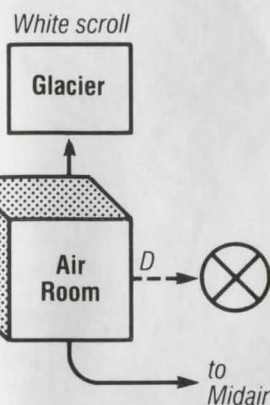
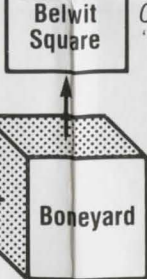
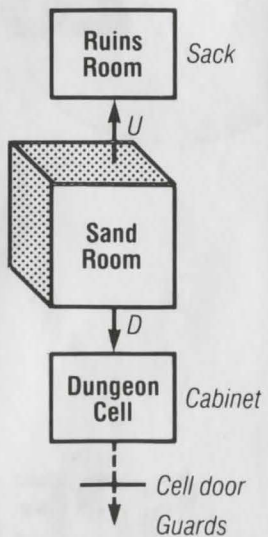
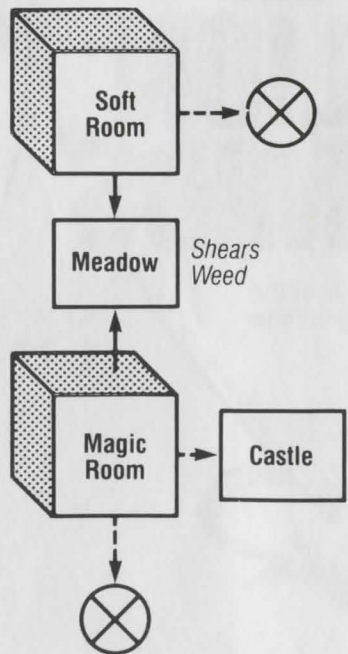
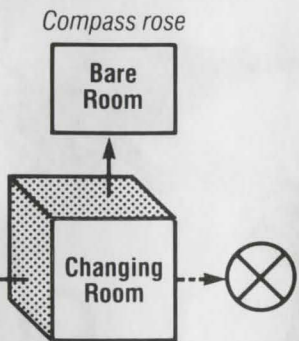
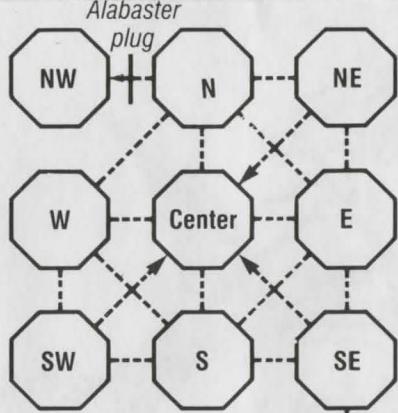

Frobozz Magic Magic Equipment Company



“Map Your Future” Sweepstakes!

**NO PURCHASE
NECESSARY TO
ENTER OR WIN**

Official Rules

To enter, follow the instructions on the preceding page. Sweepstakes open to all residents of the Great Underground Empire except employees of Frobozzco International, its affiliates, subsidiaries, advertising and production agencies, and the families of each. Entries must be received by the first day of 967 GUE. Your individual sweepstakes number will be compared against a list of winning numbers selected in a random drawing by the President of Frobozzco International. All winners will be notified by mail. Unclaimed prizes or prizes returned to the sponsor as undeliverable will be awarded to employees of Frobozzco International. We cannot be responsible for lost, late, misdirected, or enchanted mail. Entry authorizes use of any prizewinner's name and photograph by Frobozzco International without further compensation. This sweepstakes may be used in conjunction with other mailings, including those for Frobozz Enchanter's Choice Book Plan and Frobozz Newt-of-the-Month Club. All local laws and regulations apply.

INFOCOM™